

# Hip&Knee Catalogue

Inherited/Classic/Efficient/Stable

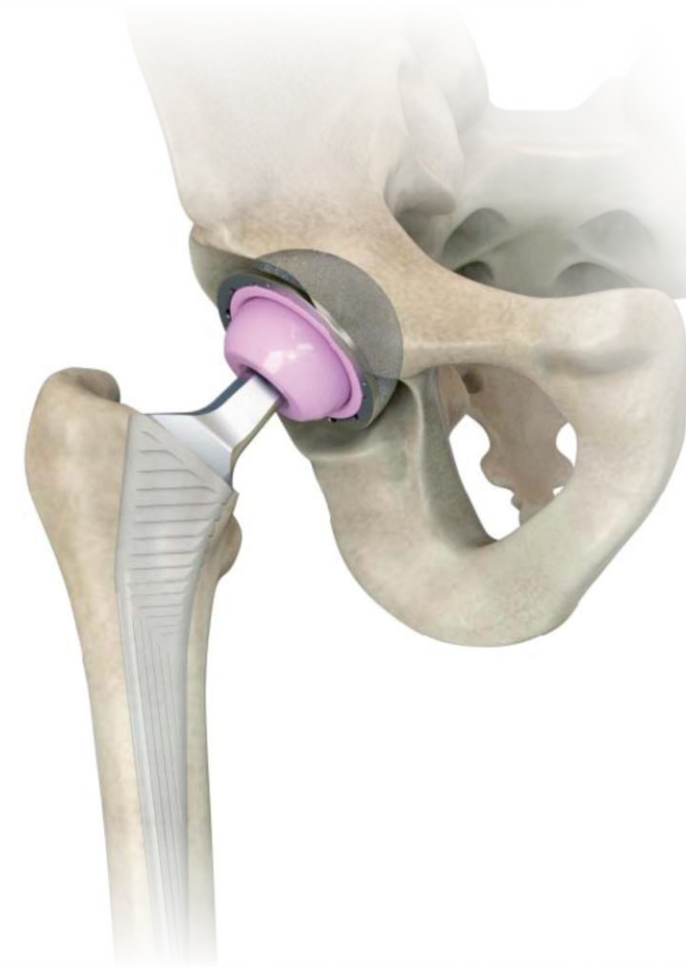
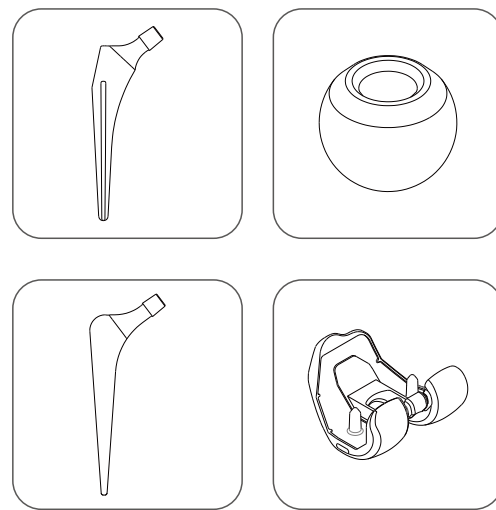

**Manufacturing Center:**  
**Wuhan Mindray Scientific Co., Ltd.**  
No.18, Qinglinghe Road, Hongshan District, Wuhan City,  
430065 Hubei Province, P.R.China

**Sales Center:**  
**Shenzhen Mindray Bio-Medical Electronics Co., Ltd.**  
Mindray Building, Keji 12th Road South, High-tech Industrial Park  
Nanshan, Shenzhen 518057, P.R. China  
Tel:+86 755 81887199 Fax:+86 755 26582680  
Email:orthopaedics@mindray.com  
Website:www.mindray.com



14,000+ employees from  
30+ countries  
52 subsidiaries across the globe

Serving 190+  
countries and regions  
\$3.9 billion revenues in 2021

### Vision

Better healthcare for all

### Mission

Advance medical technologies to make healthcare more accessible

### Core Values

- Align with our customers
- Value and enrich our people
- Be precise and practical
- Always forge ahead



Founded in 1991, Mindray is one of the leading global providers of medical devices and solutions. Firmly committed to our mission, we employ advanced technologies and transform them into innovation adapted to clinical scenarios, bringing healthcare within reach with our sound global R&D, marketing and service network. While improving the quality of care, we make it more accessible to a larger part of the world.

Mindray's innovations cover a broad spectrum of medical industry. We offer integrated solutions that adapt to different departments to help healthcare providers leverage efficiency and reinforce management.

Mindray's 52 subsidiaries are serving over 190 countries and regions around the world. Over 14,000 employees from 30 countries have chosen to join us, and a quarter of them are R&D experts who explore the most advanced medical technology. Mindray's innovative solutions are recognized and chosen by top-tier institutes worldwide, supporting the frontline caregivers where needed.

As the fourth product line of Mindray, Mindray Orthopaedics is one of the leading manufacturers of orthopaedics, providing full range of products and solutions including trauma, spine, hip&knee prosthesis, instruments, etc.

In China, we have 30 branch offices. Orthopaedic products are serving more than 40 countries and regions overseas.

We look forward to cooperating with you on our orthopaedic products with our innovation, dedication and care.



**Content**

Acetabular Cup	01
Femoral Head	10
Femoral Stem	12
Hip Revise System	23
Primary Knee Arthroplasty	26



MH™ Acetabular Cup Tri-holes

P/N	Materials	Outer diameter (mm)	Inner diameter(mm)
F13AB-PA00503	Titanium alloy +Titanium	44	36
F13AB-PA00504	Titanium alloy +Titanium	46	38
F13AB-PA00505	Titanium alloy +Titanium	48	40
F13AB-PA00506	Titanium alloy +Titanium	50	42
F13AB-PA00507	Titanium alloy +Titanium	52	44
F13AB-PA00508	Titanium alloy +Titanium	54	46
F13AB-PA00509	Titanium alloy +Titanium	56	48
F13AB-PA00510	Titanium alloy +Titanium	58	50
F13AB-PA00511	Titanium alloy +Titanium	60	52
F13AB-PA00512	Titanium alloy +Titanium	62	54
F13AB-PA00513	Titanium alloy +Titanium	64	54



MH™ Acetabular Liner

P/N	Materials	Outer diameter (mm)	Inner diameter(mm)
F13AB-PA00493	UHMWPE	36	28
F13AB-PA00494	UHMWPE	38	28
F13AB-PA00495	UHMWPE	40	32
F13AB-PA00496	UHMWPE	42	32
F13AB-PA00497	UHMWPE	44	32
F13AB-PA00498	UHMWPE	46	32
F13AB-PA00499	UHMWPE	48	32
F13AB-PA00500	UHMWPE	50	32
F13AB-PA00501	UHMWPE	52	32
F13AB-PA00502	UHMWPE	54	32



MH™ Acetabular Liner XLPE

P/N	Materials	Outer diameter (mm)	Inner diameter(mm)
F13AB-PA00403	High Cross Linked Polyethylene	40	28
F13AB-PA00404	High Cross Linked Polyethylene	42	28
F13AB-PA00414	High Cross Linked Polyethylene	44	32
F13AB-PA00415	High Cross Linked Polyethylene	46	32
F13AB-PA00416	High Cross Linked Polyethylene	48	32
F13AB-PA00417	High Cross Linked Polyethylene	50	32
F13AB-PA00418	High Cross Linked Polyethylene	52	32
F13AB-PA00419	High Cross Linked Polyethylene	54	32
F13AB-PA00423	High Cross Linked Polyethylene	48	36
F13AB-PA00424	High Cross Linked Polyethylene	50	36
F13AB-PA00425	High Cross Linked Polyethylene	52	36
F13AB-PA00426	High Cross Linked Polyethylene	54	36



MH™ Acetabular Liner XLPE

P/N	Materials	Outer diameter (mm)	Inner diameter(mm)
F13AB-PA00366	High Cross Linked Polyethylene	36	28
F13AB-PA00367	High Cross Linked Polyethylene	38	28
F13AB-PA00377	High Cross Linked Polyethylene	40	32
F13AB-PA00378	High Cross Linked Polyethylene	42	32
F13AB-PA00386	High Cross Linked Polyethylene	44	36
F13AB-PA00387	High Cross Linked Polyethylene	46	36



MH™ Ceramic Liner-Delta

P/N	Materials	Outer diameter (mm)	Inner diameter(mm)
F13AB-PA00527	Ceramic	36	28
F13AB-PA00528	Ceramic	38	28
F13AB-PA00530	Ceramic	40	32
F13AB-PA00531	Ceramic	42	32
F13AB-PA00533	Ceramic	44	36
F13AB-PA00534	Ceramic	46	36
F13AB-PA00535	Ceramic	48	36
F13AB-PA00536	Ceramic	50	36
F13AB-PA00537	Ceramic	52	36
F13AB-PA00538	Ceramic	54	36



MH™ Plug-Bottom Hole

P/N	Materials	Diameter(mm)	Length(mm)
F13AB-PA00514	Titanium alloy	10	4



MH™ Plug -Screw Hole

P/N	Materials	Diameter(mm)	Length(mm)
F13AB-PA00515	Titanium alloy	8	3



Screw for Acetabular Cup

P/N	Materials	Diameter(mm)	Length(mm)
J2012-1-6315	Titanium alloy	6.3	15
F13AB-PA00128	Titanium alloy	6.3	20
F13AB-PA00129	Titanium alloy	6.3	25
F13AB-PA00130	Titanium alloy	6.3	30
F13AB-PA00131	Titanium alloy	6.3	35
F13AB-PA00139	Titanium alloy	6.3	40



Acetabular Component

P/N	Materials	Outer diameter (mm)	Inner diameter(mm)
F13AB-PA00009	Titanium alloy +HA coating	42	24
F13AB-PA00010	Titanium alloy +HA coating	44	24
F13AB-PA00011	Titanium alloy +HA coating	46	24
F13AB-PA00012	Titanium alloy +HA coating	48	28
F13AB-PA00013	Titanium alloy +HA coating	50	28
F13AB-PA00014	Titanium alloy +HA coating	52	28
F13AB-PA00015	Titanium alloy +HA coating	54	28
F13AB-PA00016	Titanium alloy +HA coating	56	28
F13AB-PA00017	Titanium alloy +HA coating	58	28
F13AB-PA00018	Titanium alloy +HA coating	60	28
F13AB-PA00019	Titanium alloy +HA coating	62	28



Acetabular Component

\*Note: These products are only available in selected countries. Please consult local sales for details.

P/N	Materials	Outer diameter (mm)	Inner diameter(mm)
F13AB-PA00610	Titanium alloy +HA coating	42	24
F13AB-PA00611	Titanium alloy +HA coating	44	24
F13AB-PA00612	Titanium alloy +HA coating	46	24
F13AB-PA00613	Titanium alloy +HA coating	48	28
F13AB-PA00614	Titanium alloy +HA coating	50	28
F13AB-PA00615	Titanium alloy +HA coating	52	28
F13AB-PA00616	Titanium alloy +HA coating	54	28
F13AB-PA00617	Titanium alloy +HA coating	56	28
F13AB-PA00618	Titanium alloy +HA coating	58	28
F13AB-PA00619	Titanium alloy +HA coating	60	28
F13AB-PA00620	Titanium alloy +HA coating	62	28



All-Polyethylene Cup

P/N	Materials	Outer diameter (mm)	Inner diameter(mm)
F13AB-PA00001	UHMWPE+Stainless Steel	42	28
F13AB-PA00002	UHMWPE+Stainless Steel	44	28
F13AB-PA00003	UHMWPE+Stainless Steel	46	28
F13AB-PA00004	UHMWPE+Stainless Steel	48	28
F13AB-PA00005	UHMWPE+Stainless Steel	50	28
F13AB-PA00006	UHMWPE+Stainless Steel	52	28
F13AB-PA00007	UHMWPE+Stainless Steel	54	28
F13AB-PA00008	UHMWPE+Stainless Steel	56	28



Acetabular System Instrument Set (F16AB-PA00002)

P/N	Name	Specification	No	Qty
F16AB-PA00026	Reamer Domes Φ42	Φ42	1	1
F16AB-PA00027	Reamer Domes Φ44	Φ44	2	1
F16AB-PA00028	Reamer Domes Φ46	Φ46	3	1
F16AB-PA00029	Reamer Domes Φ48	Φ48	4	1
F16AB-PA00030	Reamer Domes Φ50	Φ50	5	1
F16AB-PA00031	Reamer Domes Φ52	Φ52	6	1
F16AB-PA00032	Reamer Domes Φ54	Φ54	7	1
F16AB-PA00033	Reamer Domes Φ56	Φ56	8	1
F16AB-PA00034	Reamer Domes Φ58	Φ58	9	1
F16AB-PA00035	Reamer Domes Φ60	Φ60	10	1
F16AB-PA00512	Reamer Domes Φ40	Φ40	11	1
F16AB-PA00514	Reamer Domes Φ43	Φ43	12	1
F16AB-PA00515	Reamer Domes Φ45	Φ45	13	1
F16AB-PA00516	Reamer Domes Φ47	Φ47	14	1
F16AB-PA00517	Reamer Domes Φ49	Φ49	15	1
F16AB-PA00518	Reamer Domes Φ51	Φ51	16	1
F16AB-PA00519	Reamer Domes Φ53	Φ53	17	1
F16AB-PA00520	Reamer Domes Φ55	Φ55	18	1
F16AB-PA00521	Reamer Domes Φ57	Φ57	19	1
F16AB-PA00522	Reamer Domes Φ59	Φ59	20	1
F16AB-PA00025	Reamer Handle	/	21	1
F16AB-PA00004	Trial Cup Φ44	Φ44	22	1
F16AB-PA00005	Trial Cup Φ46	Φ46	23	1
F16AB-PA00006	Trial Cup Φ48	Φ48	24	1
F16AB-PA00007	Trial Cup Φ50	Φ50	25	1
F16AB-PA00008	Trial Cup Φ52	Φ52	26	1
F16AB-PA00009	Trial Cup Φ54	Φ54	27	1
F16AB-PA00010	Trial Cup Φ56	Φ56	28	1
F16AB-PA00011	Trial Cup Φ58	Φ58	29	1
F16AB-PA00012	Trial Cup Φ60	Φ60	30	1
F16AB-PA00016	Metal Cup Inserter	/	31	1
F16AB-PA00017	Metal Cup Alignment Guide	/	32	1
F16AB-PA00462	Drill Bit Φ3.2*30	Φ47	33	1
F16AB-PA00463	Drill Bit Φ3.2*37	Φ49	34	1
F16AB-PA00019	VA Drill Guide	/	35	1
F16AB-PA00020	Variable Angle StarDrive Screwdriver	/	36	1
F16AB-PA00529	Ratchet Screwdriver Handle	/	37	1
F16AB-PA00023	Screw Forceps	/	38	1
F16AB-PA00040	Depth Gauge	/	39	1
F16AB-PA00018	Guide Wire	/	40	1
F16AB-PA00021	Liner Inserter 24	24	41	1
F16AB-PA00022	Liner Inserter 28	28	42	1

P/N	Name	Specification	No	Qty
F16AB-PA00469	Liner Inserter 32	32	43	1
F16AB-PA00510	Liner Inserter 36	36	44	1
F16AB-PA00526	Instrument Case	/	45	1
			Total	45



Option (※ are Optional tools)

P/N	Name	Specification	No	Qty
F16AB-PA00511	Reamer Domes Φ38	Φ38	※1	1
F16AB-PA00513	Reamer Domes Φ41	Φ41	※2	1
F16AB-PA00523	Reamer Domes Φ61	Φ61	※3	1
F16AB-PA00036	Reamer Domes Φ62	Φ62	※4	1
F16AB-PA00524	Reamer Domes Φ63	Φ63	※5	1
F16AB-PA00525	Reamer Domes Φ64	Φ64	※6	1
F16AB-PA00003	Trial Cup Φ42	Φ42	※7	1
F16AB-PA00013	Trial Cup Φ62	Φ62	※8	1
F16AB-PA00497	Trial Cup Φ64	Φ64	※9	1
F16AB-PA00014	Quick Coupling	/	※10	1
F16AB-PA00024	Poly Cup Inserter	/	※11	1
F16AB-PA00039	Poly Liner Separator	/	※12	1
F16AB-PA00544	Ceramic Liner Extractor	/	※13	1
F16AB-PA00545	Drill Guide	/	※14	1
F16AB-PA00550	Straight Shank Stardrive Screwdriver	/	※15	1

MH™ Hip Joint Instrument Upgrade Set (F16AB-PA00470)

P/N	Name	Specification	No	Qty
F16AB-PA00465	Trial Femoral Head 32S	32S	1	1
F16AB-PA00466	Trial Femoral Head 32M	32M	2	1
F16AB-PA00467	Trial Femoral Head 32L	32L	3	1
F16AB-PA00468	Trial Femoral Head 32XL	32XL	4	1
F16AB-PA00498	Trial Femoral Head 36S	36S	5	1
F16AB-PA00499	Trial Femoral Head 36M	36M	6	1
F16AB-PA00500	Trial Femoral Head 36L	36L	7	1
F16AB-PA00501	Trial Femoral Head 36XL	36XL	8	1
F16AB-PA00021	Liner Inserter 24	24	9	1
F16AB-PA00022	Liner Inserter 28	28	10	1
F16AB-PA00469	Liner Inserter 32	32	11	1
F16AB-PA00510	Liner Inserter 36	36	12	1
			Total	12



Bipolar Head MH™

P/N	Materials	Outer diameter (mm)	Inner diameter(mm)
F13AB-PA00048	S+UHMWPE	38	24
F13AB-PA00049	S+UHMWPE	40	24
F13AB-PA00050	S+UHMWPE	42	24
F13AB-PA00051	S+UHMWPE	44	24
F13AB-PA00642	S+UHMWPE	42	28
F13AB-PA00643	S+UHMWPE	44	28
F13AB-PA00052	S+UHMWPE	46	28
F13AB-PA00053	S+UHMWPE	48	28
F13AB-PA00054	S+UHMWPE	50	28
F13AB-PA00055	S+UHMWPE	52	28
F13AB-PA00056	S+UHMWPE	54	28



Bipolar Trial Tray (F16AB-PA00412)

P/N	Name	Specification	No	Qty
F16AB-PA00389	Bipolar Trial 38/24	38/24	1	1
F16AB-PA00390	Bipolar Trial 40/24	40/24	2	1
F16AB-PA00391	Bipolar Trial 42/24	42/24	3	1
F16AB-PA00392	Bipolar Trial 44/24	44/24	4	1
F16AB-PA00393	Bipolar Trial 46/28	46/28	5	1
F16AB-PA00394	Bipolar Trial 48/28	48/28	6	1
F16AB-PA00395	Bipolar Trial 50/28	50/28	7	1
F16AB-PA00396	Bipolar Trial 52/28	52/28	8	1
F16AB-PA00397	Bipolar Trial 54/28	54/28	9	1
F16AB-PA00086	Grip	/	10	1
F16AB-PA00413	Bipolar Instrument Case	/	11	1
			Total	11



Ceramic Head-Forte

P/N	Materials	Size (mm)	Neck length(mm)
F13AB-PA00031	Al2O3	28-12/14S	-3.5
F13AB-PA00032	Al2O3	28-12/14M	0
F13AB-PA00033	Al2O3	28-12/14L	+3.5



Ceramic Head-Delta

P/N	Materials	Size (mm)	Neck length(mm)
F13AB-PA00516	Ceramic	28S	-3.5
F13AB-PA00517	Ceramic	28M	0
F13AB-PA00518	Ceramic	28L	+3.5
F13AB-PA00519	Ceramic	32S	-4
F13AB-PA00520	Ceramic	32M	0
F13AB-PA00521	Ceramic	32L	+4
F13AB-PA00522	Ceramic	32XL	+8
F13AB-PA00523	Ceramic	36S	-4
F13AB-PA00524	Ceramic	36M	0
F13AB-PA00525	Ceramic	36L	+4
F13AB-PA00526	Ceramic	36XL	+8



Ceramic Head-Delta

P/N	Materials	Size (mm)	Neck length(mm)
F13AB-PA00035	CoCrMo casted	24S	-3.5
F13AB-PA00037	CoCrMo casted	24M	0
F13AB-PA00039	CoCrMo casted	24L	3.5
F13AB-PA00041	CoCrMo casted	28S	-3.5
F13AB-PA00043	CoCrMo casted	28M	0
F13AB-PA00045	CoCrMo casted	28L	+3.5
F13AB-PA00047	CoCrMo casted	28XL	+7
F13AB-PA00353	CoCrMo casted	32S	-4
F13AB-PA00354	CoCrMo casted	32M	0
F13AB-PA00355	CoCrMo casted	32L	+4
F13AB-PA00356	CoCrMo casted	32XL	+8



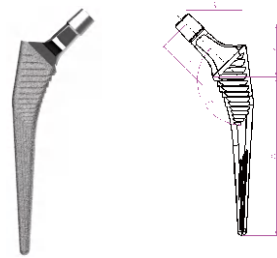

MH™ NEOS Primary Stem

P/N	Materials	Size	Stem length (mm)	Base offset (mm)	Neck length (mm)	Leg length adj.(mm)	Neck Angle	Specification on the label	
								Distal Width (mm)	Length (mm)
								A	B
F13AB-PA00584	Titanium alloy +Titanium	1	108.3	38.3	38.2	38.2	135°	5	130
F13AB-PA00585	Titanium alloy +Titanium	2	118.5	39.3	38.2	38.2	135°	6	140
F13AB-PA00586	Titanium alloy +Titanium	3	123.8	39.8	38.2	38.2	135°	7	145
F13AB-PA00587	Titanium alloy +Titanium	4	128.2	40.8	38.2	38.2	135°	8	150
F13AB-PA00588	Titanium alloy +Titanium	5	133.5	41.3	38.2	38.2	135°	9	155
F13AB-PA00589	Titanium alloy +Titanium	6	138.4	41.8	38.2	38.2	135°	10	160
F13AB-PA00590	Titanium alloy +Titanium	7	142.9	42.8	38.2	38.2	135°	11	165

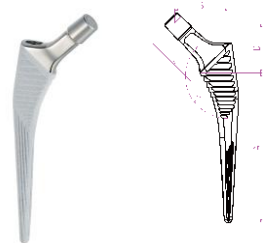

NEOS Primary Stem

P/N	Materials	Size	Stem length (mm)	Base offset (mm)	Neck length (mm)	Leg length adj.(mm)	Neck Angle	Specification on the label	
								Distal Width (mm)	Length (mm)
								A	B
F13AB-PA00200	Titanium alloy +HA coating	0	93.3	38	38.5	35.8	135°	5	115
F13AB-PA00201	Titanium alloy +HA coating	1	108.3	38.3	38.2	36	135°	5	130
F13AB-PA00202	Titanium alloy +HA coating	2	118.5	39.3	38.2	35.3	135°	6	140
F13AB-PA00203	Titanium alloy +HA coating	3	123.8	39.8	38.2	35.8	135°	7	145
F13AB-PA00204	Titanium alloy +HA coating	4	128.2	40.8	38.2	35.6	135°	8	150
F13AB-PA00205	Titanium alloy +HA coating	5	133.5	41.3	38.2	35.5	135°	9	155
F13AB-PA00206	Titanium alloy +HA coating	6	138.4	41.8	38.2	35.8	135°	10	160
F13AB-PA00207	Titanium alloy +HA coating	7	142.9	42.8	38.2	35.6	135°	11	165

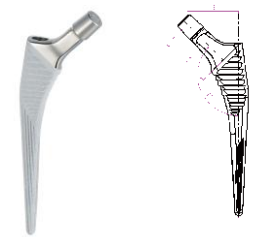

NEOS Primary Stem

\*Note: These products are only available in selected countries. Please consult local sales for details.

P/N	Materials	Size	Stem length (mm)	Base offset (mm)	Neck length (mm)	Leg length adj.(mm)	Neck Angle	Specification on the label	
								Distal Width (mm)	Length (mm)
								A	B
F13AB-PA00602	Titanium alloy +HA coating	0	93.3	38	38.5	35.8	135°	5	115
F13AB-PA00603	Titanium alloy +HA coating	1	108.3	38.3	38.2	36	135°	5	130
F13AB-PA00604	Titanium alloy +HA coating	2	118.5	39.3	38.2	35.3	135°	6	140
F13AB-PA00605	Titanium alloy +HA coating	3	123.8	39.8	38.2	35.8	135°	7	145
F13AB-PA00606	Titanium alloy +HA coating	4	128.2	40.8	38.2	35.6	135°	8	150
F13AB-PA00607	Titanium alloy +HA coating	5	133.5	41.3	38.2	35.5	135°	9	155
F13AB-PA00608	Titanium alloy +HA coating	6	138.4	41.8	38.2	35.8	135°	10	160
F13AB-PA00609	Titanium alloy +HA coating	7	142.9	42.8	38.2	35.6	135°	11	165

NEOS Primary Stem Instrument Set (F16AB-PA00386)

P/N	Name	Specification	No	Qty
F16AB-PA00308	Neos Neck Resection Guide	/	1	1
F16AB-PA00044	Medullary Initiator	/	2	1
F16AB-PA00059	Trial Femoral Head 28S	28S	3	1
F16AB-PA00060	Trial Femoral Head 28M	28M	4	1
F16AB-PA00061	Trial Femoral Head 28L	28L	5	1
F16AB-PA00062	Trial Femoral Head 28XL	28XL	6	1
F16AB-PA00063	Trial Femoral Head 24S	24S	7	1
F16AB-PA00064	Trial Femoral Head 24M	24M	8	1
F16AB-PA00065	Trial Femoral Head 24L	24L	9	1
F16AB-PA00465	Trial Femoral Head 32S	32S	10	1
F16AB-PA00466	Trial Femoral Head 32M	32M	11	1
F16AB-PA00467	Trial Femoral Head 32L	32L	12	1
F16AB-PA00468	Trial Femoral Head 32XL	32XL	13	1
F16AB-PA00498	Trial Femoral Head 36S	36S	14	1
F16AB-PA00499	Trial Femoral Head 36M	36M	15	1
F16AB-PA00500	Trial Femoral Head 36L	36L	16	1
F16AB-PA00501	Trial Femoral Head 36XL	36XL	17	1
F16AB-PA00067	Femoral Head Impactor	/	18	1
F16AB-PA00312	Medullary Reamer Explorer	/	19	1
F16AB-PA00530	Retractor 20	20	20	1
F16AB-PA00531	Retractor 30	30	21	1
F16AB-PA00532	Retractor 40	40	22	1
F16AB-PA00533	Retractor Dovetail	/	23	1
F16AB-PA00134	Neos Stem Inserter Accessory	/	24	1
F16AB-PA00087	Hand File	/	25	1
F16AB-PA00300	Neos Broach 0	0	26	1
F16AB-PA00301	Neos Broach 1	1	27	1
F16AB-PA00302	Neos Broach 2	2	28	1
F16AB-PA00303	Neos Broach 3	3	29	1
F16AB-PA00304	Neos Broach 4	4	30	1
F16AB-PA00305	Neos Broach 5	5	31	1
F16AB-PA00306	Neos Broach 6	6	32	1
F16AB-PA00307	Neos Broach 7	7	33	1
F16AB-PA00309	Bone Compactor	/	34	1
F16AB-PA00311	Neos Trial Neck	/	35	1
F16AB-PA00388	Neos Broach Extractor	/	36	1
F16AB-PA00410	Head Extractor	/	37	1
F16AB-PA00411	Mallet	/	38	1
F16AB-PA00375	T-handle	/	39	1
F16AB-PA00111	Neos Stem Inserter	/	40	1
F16AB-PA00081	Calcar Planer	/	41	1
F16AB-PA00527	Instrument Case	/	42	1
			Total	42

Option (※ are Optional tools)

P/N	Name	Specification	No	Qty
F16AB-PA00542	Medullary Reamer Φ9.5	Φ9.5	※1	1
F16AB-PA00543	Medullary Reamer Φ10.5	Φ10.5	※2	1

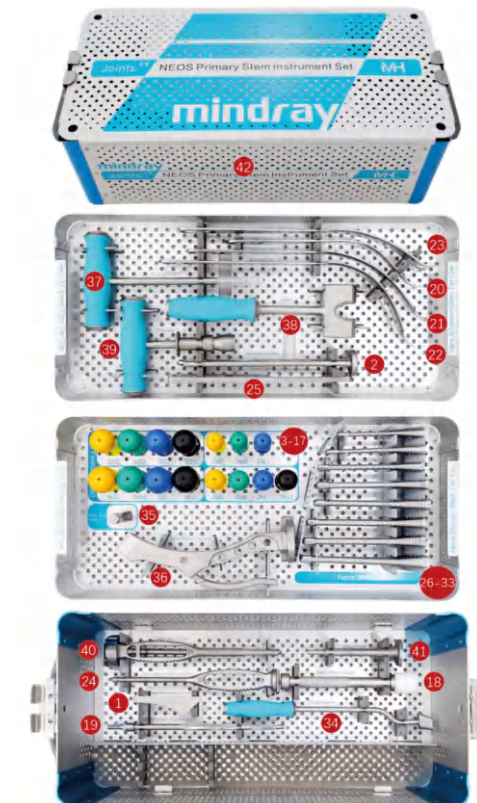

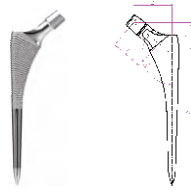

MH™ Tapered Stem

P/N	Materials	Size	Stem length (mm)	Base offset (mm)	Neck length (mm)	Leg length adj. (mm)	Neck Angle	Specification on the label	
								Distal Width (mm)	Length (mm)
								A	B
F13AB-PA00594	Titanium alloy +Titanium	1	125	36	31	27	130°	6	140
F13AB-PA00595	Titanium alloy +Titanium	2	130	38	32	28	130°	7	145
F13AB-PA00596	Titanium alloy +Titanium	3	135	38	32	29	130°	8	151
F13AB-PA00597	Titanium alloy +Titanium	4	140	40	34	30	130°	9	156
F13AB-PA00598	Titanium alloy +Titanium	5	145	40	34	31	130°	10	162
F13AB-PA00599	Titanium alloy +Titanium	6	150	42	36	32	130°	11	167
F13AB-PA00600	Titanium alloy +Titanium	7	155	42	36	33	130°	12	173



Tapered Stem

P/N	Materials	Size	Stem length (mm)	Base offset (mm)	Neck length (mm)	Leg length adj. (mm)	Neck Angle	Specification on the label	
								Distal Width (mm)	Length (mm)
								A	B
F13AB-PA00091	Titanium alloy +HA coating	1	125	36	31	27	130°	6	140
F13AB-PA00092	Titanium alloy +HA coating	2	130	38	32	28	130°	7	145
F13AB-PA00093	Titanium alloy +HA coating	3	135	38	32	29	130°	8	151
F13AB-PA00094	Titanium alloy +HA coating	4	140	40	34	30	130°	9	156
F13AB-PA00095	Titanium alloy +HA coating	5	145	40	34	31	130°	10	162
F13AB-PA00096	Titanium alloy +HA coating	6	150	42	36	32	130°	11	167
F13AB-PA00097	Titanium alloy +HA coating	7	155	42	36	33	130°	12	173

Tapered Stem Instrument Set (F16AB-PA00094)

P/N	Name	Specification	No	Qty
F16AB-PA00044	Medullary Initiator	/	1	1
F16AB-PA00059	Trial Femoral Head 28S	28S	2	1
F16AB-PA00060	Trial Femoral Head 28M	28M	3	1
F16AB-PA00061	Trial Femoral Head 28L	28L	4	1
F16AB-PA00062	Trial Femoral Head 28XL	28XL	5	1
F16AB-PA00063	Trial Femoral Head 24S	24S	6	1
F16AB-PA00064	Trial Femoral Head 24M	24M	7	1
F16AB-PA00065	Trial Femoral Head 24L	24L	8	1
F16AB-PA00465	Trial Femoral Head 32S	32S	9	1
F16AB-PA00066	Trial Femoral Head 32M	32M	10	1
F16AB-PA00467	Trial Femoral Head 32L	32L	11	1
F16AB-PA00468	Trial Femoral Head 32XL	32XL	12	1
F16AB-PA00498	Trial Femoral Head 36S	36S	13	1
F16AB-PA00499	Trial Femoral Head 36M	36M	14	1
F16AB-PA00500	Trial Femoral Head 36L	36L	15	1
F16AB-PA00501	Trial Femoral Head 36XL	36XL	16	1
F16AB-PA00067	Femoral Head Impactor	/	17	1
F16AB-PA00112	Tapered Medullary Reamer Proximal	/	18	1
F16AB-PA00113	Medullary Reamer Explorer	/	19	1
F16AB-PA00123	Tapered Medullary Reamer 1	1	20	1
F16AB-PA00124	Tapered Medullary Reamer 2&3	2&3	21	1
F16AB-PA00125	Tapered Medullary Reamer 4&5	4&5	22	1
F16AB-PA00126	Tapered Medullary Reamer 6&7	6&7	23	1
F16AB-PA00085	Tapered Neck Resection Guide	/	24	1
F16AB-PA00087	Hand File	/	25	1
F16AB-PA00530	Retractor 20	20	26	1
F16AB-PA00531	Retractor 30	30	27	1
F16AB-PA00532	Retractor 40	40	28	1
F16AB-PA00533	Retractor Dovetail	/	29	1
F16AB-PA00134	Neos Stem Inserter Accessory	/	30	1
F16AB-PA00410	Head Extractor	/	31	1
F16AB-PA00411	Mallet	/	32	1
F16AB-PA00375	T-handle	/	33	1
F16AB-PA00047	Tapered Broach Extractor	/	34	1
F16AB-PA00100	Tapered Broach 1	1	35	1
F16AB-PA00101	Tapered Broach 2	2	36	1
F16AB-PA00102	Tapered Broach 3	3	37	1
F16AB-PA00103	Tapered Broach 4	4	38	1
F16AB-PA00104	Tapered Broach 5	5	39	1
F16AB-PA00105	Tapered Broach 6	6	40	1
F16AB-PA00106	Tapered Broach 7	7	41	1
F16AB-PA00107	Tapered Trial Neck 1	1	42	1

P/N	Name	Specification	No	Qty
F16AB-PA00108	Tapered Trial Neck 2&3	2&3	43	1
F16AB-PA00109	Tapered Trial Neck 4&5	4&5	44	1
F16AB-PA00110	Tapered Trial Neck 6&7	6&7	45	1
F16AB-PA00111	Neos Stem Inserter	/	46	1
F16AB-PA00081	Calcar Planer	/	47	1
F16AB-PA00528	Instrument Case	/	48	1
			Total	48

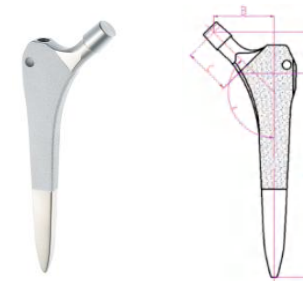
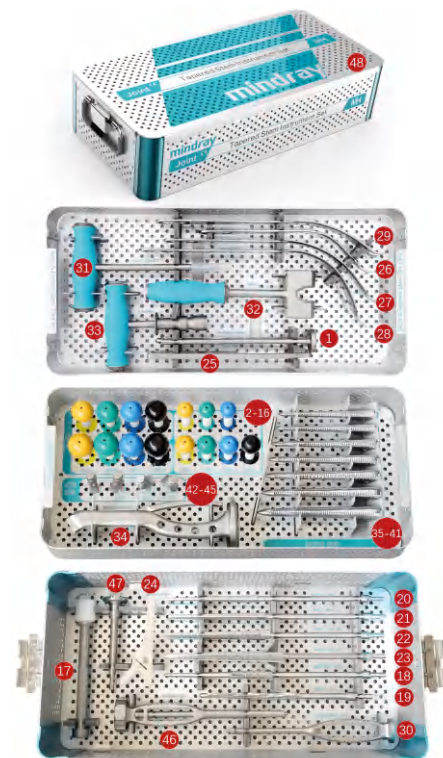

Wedge-shaped Stem

P/N	Materials	Size	Stem length (mm)	Base offset (mm)	Neck length (mm)	Leg length adj.(mm)	Neck Angle	Specification on the label	
								Distal Width (mm)	Length (mm)
			A	B	C	D	E		
F13AB-PA00075	Titanium alloy +HA coating	01	112.5	33	27.5	24.5	135°	7	129
F13AB-PA00076	Titanium alloy +HA coating	0	116.5	34	27.5	24.5	135°	8	133
F13AB-PA00077	Titanium alloy +HA coating	1	119	35	29.5	26	135°	9	137
F13AB-PA00078	Titanium alloy +HA coating	2	123	36	29.5	26	135°	10	141
F13AB-PA00079	Titanium alloy +HA coating	3	127	37	29.5	26	135°	11	145
F13AB-PA00080	Titanium alloy +HA coating	4	129.5	38	31.5	27.5	135°	12	149
F13AB-PA00081	Titanium alloy +HA coating	5	133.5	39	31.5	27.5	135°	13	153
F13AB-PA00082	Titanium alloy +HA coating	6	139	41	31.5	27.5	135°	14	158

Wedge-shaped Stem Instrument Set (F16AB-PA00042)

P/N	Name	Specification	No	Qty
F16AB-PA00410	Head Extractor	/	1	1
F16AB-PA00044	Medullary Initiator	/	2	1
F16AB-PA00411	Mallet	/	3	1
F16AB-PA00046	Floating Ruler	/	4	1
F16AB-PA00047	Tapered Broach Extractor	/	5	1
F16AB-PA00048	Broach 01	01	6	1
F16AB-PA00049	Broach 0	0	7	1
F16AB-PA00050	Broach 1	1	8	1
F16AB-PA00051	Broach 2	2	9	1
F16AB-PA00052	Broach 3	3	10	1
F16AB-PA00053	Broach 4	4	11	1
F16AB-PA00054	Broach 5	5	12	1
F16AB-PA00055	Broach 6	6	13	1
F16AB-PA00056	Trial Neck 01&0	01&0	14	1
F16AB-PA00057	Trial Neck 123	123	15	1
F16AB-PA00058	Trial Neck 456	456	16	1



P/N	Name	Specification	No	Qty
F16AB-PA00059	Trial Femoral Head 28S	28S	17	1
F16AB-PA00060	Trial Femoral Head 28M	28M	18	1
F16AB-PA00061	Trial Femoral Head 28L	28L	19	1
F16AB-PA00062	Trial Femoral Head 28XL	28XL	20	1
F16AB-PA00063	Trial Femoral Head 24S	24S	21	1
F16AB-PA00064	Trial Femoral Head 24M	24M	22	1
F16AB-PA00065	Trial Femoral Head 24L	24L	23	1
F16AB-PA00066	Stem Inserter	/	24	1
F16AB-PA00067	Femoral Head Impactor	/	25	1
F16AB-PA00375	T-handle	/	26	1
F16AB-PA00069	Medullary Reamer Φ7	Φ7	27	1
F16AB-PA00070	Medullary Reamer Φ8	Φ8	28	1
F16AB-PA00071	Medullary Reamer Φ9	Φ9	29	1
F16AB-PA00072	Medullary Reamer Φ10	Φ10	30	1
F16AB-PA00073	Medullary Reamer Φ11	Φ11	31	1
F16AB-PA00074	Medullary Reamer Φ12	Φ12	32	1
F16AB-PA00081	Calcar Planer	/	33	1
F16AB-PA00085	Tapered Neck Resection Guide	/	34	1
F16AB-PA00086	Grip	/	35	1
F16AB-PA00087	Hand File	/	36	1
F16AB-PA00088	Retractor 20	20	37	1
F16AB-PA00089	Retractor 30	30	38	1
F16AB-PA00090	Retractor 40	40	39	1
F16AB-PA00015	Trial Cup Connector	/	40	1
F16AB-PA00091	Instrument Case	/	41	1
			Total	41

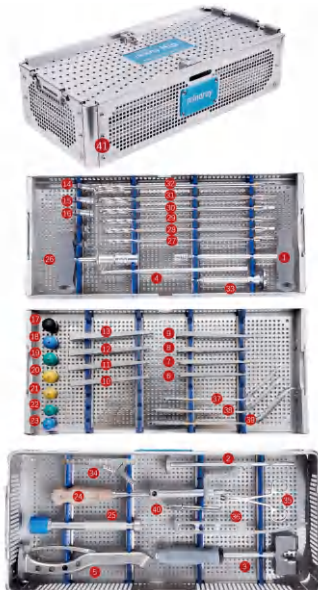

Cemented Stem-Wedge Shaped

P/N	Materials	Size	Stem length (mm)	Base offset (mm)	Neck length (mm)	Leg length adj.(mm)	Neck Angle	Specification on the label	
			A	B	C	D	E	Distal Width (mm)	Length (mm)
F13AB-PA00111	CoCrMo	0	119.5	37.5	29	23.5	130°	5.5	136
F13AB-PA00113	CoCrMo	1	119.5	38.5	30.5	25	130°	6.5	136.5
F13AB-PA00115	CoCrMo	2	119.5	40	32	26	130°	7.5	137
F13AB-PA00117	CoCrMo	3	119.5	41	33.5	27.5	130°	8.5	138
F13AB-PA00119	CoCrMo	4	119.5	42	35	28.5	130°	9	139

Note:A restrictor is included in the box with the stem.  
When used, the implanted prosthesis needs to be one size larger than the intramedullary Broach A.

Cemented Stem Instrument Set (F16AB-PA00405)

P/N	Name	Specification	No	Qty
F16AB-PA00410	Head Extractor	/	1	1
F16AB-PA00044	Medullary Initiator	/	2	1
F16AB-PA00411	Mallet	/	3	1
F16AB-PA00046	Floating Ruler	/	4	1
F16AB-PA00047	Tapered Broach Extractor	/	5	1
F16AB-PA00059	Trial Femoral Head 28S	28S	6	1
F16AB-PA00060	Trial Femoral Head 28M	28M	7	1
F16AB-PA00061	Trial Femoral Head 28L	28L	8	1
F16AB-PA00062	Trial Femoral Head 28XL	28XL	9	1
F16AB-PA00063	Trial Femoral Head 24S	24S	10	1
F16AB-PA00064	Trial Femoral Head 24M	24M	11	1
F16AB-PA00065	Trial Femoral Head 24L	24L	12	1
F16AB-PA00066	Stem Inserter	/	13	1
F16AB-PA00067	Femoral Head Impactor	/	14	1
F16AB-PA00375	T-handle	/	15	1
F16AB-PA00069	Medullary Reamer Φ7	Φ7	16	1
F16AB-PA00070	Medullary Reamer Φ8	Φ8	17	1
F16AB-PA00071	Medullary Reamer Φ9	Φ9	18	1
F16AB-PA00072	Medullary Reamer Φ10	Φ10	19	1
F16AB-PA00073	Medullary Reamer Φ12	Φ12	20	1



P/N	Name	Specification	No	Qty
F16AB-PA00074	Medullary Reamer $\Phi$ 12	$\Phi$ 12	21	1
F16AB-PA00075	Broach A 01	01	22	1
F16AB-PA00076	Broach A 0	0	23	1
F16AB-PA00077	Broach A 1	1	24	1
F16AB-PA00078	Broach A 2	2	25	1
F16AB-PA00079	Broach A 3	3	26	1
F16AB-PA00080	Broach A 4	4	27	1
F16AB-PA00081	Calcar Planer	/	28	1
F16AB-PA00398	Neck A 01,0,1	01,0,1	29	1
F16AB-PA00399	Neck A 2	2	30	1
F16AB-PA00400	Neck A 3,4	3,4	31	1
F16AB-PA00085	Tapered Neck Resection Guide	/	32	1
F16AB-PA00086	Grip	/	33	1
F16AB-PA00087	Hand File	/	34	1
F16AB-PA00088	Retractor 20	20	35	1
F16AB-PA00089	Retractor 30	30	36	1
F16AB-PA00090	Retractor 40	40	37	1
F16AB-PA00015	Trial Cup Connector	/	38	1
F16AB-PA00296	Inserter	/	39	1
F16AB-PA00409	Instrument Case	/	40	1
			Total	40

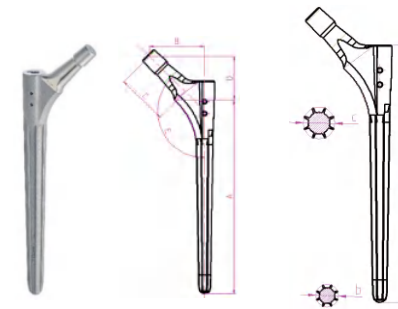
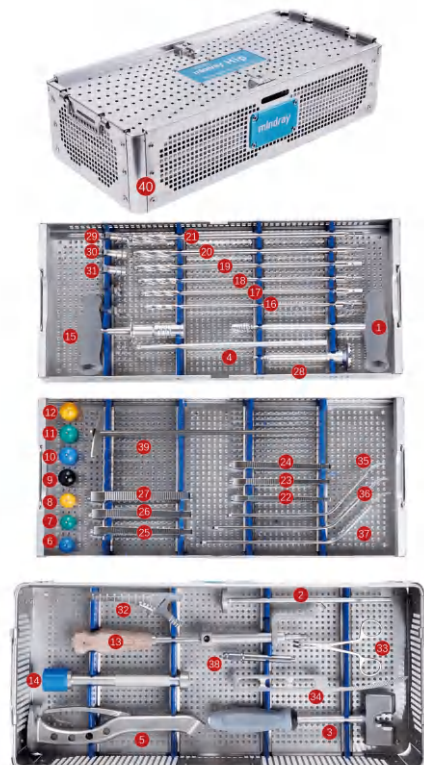

NEOS Revision Stem

P/N	Materials	Stem length (mm)	Base offset (mm)	Neck length (mm)	Leg length adj. (mm)	Neck Angle	Specification on the label		Proximal Width (mm)
							Distal Width (mm)	Length (mm)	
		A	B	C	D	E	b	L	c
F13AB-PA00208	Titanium	155	42	37.5	33	135°	8	170	14
F13AB-PA00209	Titanium	155	42	37.5	33	135°	8.5	170	15
F13AB-PA00210	Titanium	155	42	37.5	33	135°	9.5	170	16
F13AB-PA00211	Titanium	155	42	37.5	33	135°	10.5	170	17
F13AB-PA00212	Titanium	155	42	37.5	33	135°	11	170	18
F13AB-PA00213	Titanium	155	42	37.5	33	135°	11.5	170	19
F13AB-PA00214	Titanium	155	42	37.5	33	135°	12.5	170	20
F13AB-PA00215	Titanium	190	42	37.5	33	135°	8	200	14
F13AB-PA00216	Titanium	190	42	37.5	33	135°	8.5	200	15
F13AB-PA00217	Titanium	190	42	37.5	33	135°	9.5	200	16
F13AB-PA00218	Titanium	190	42	37.5	33	135°	10.5	200	17
F13AB-PA00219	Titanium	190	42	37.5	33	135°	11	200	18
F13AB-PA00220	Titanium	190	42	37.5	33	135°	11.5	200	19
F13AB-PA00221	Titanium	190	42	37.5	33	135°	12.5	200	20
F13AB-PA00222	Titanium	190	42	37.5	33	135°	13	200	21
F13AB-PA00223	Titanium	190	42	37.5	33	135°	14	200	22

NEOS Revision Stem Instrument Set (F16AB-PA00384)

P/N	Name	Specification	No	Qty
F16AB-PA00348	Neos R Trail Stem 14/170	14/170	1	1
F16AB-PA00349	Neos R Trail Stem 15/170	15/170	2	1
F16AB-PA00350	Neos R Trail Stem 16/170	16/170	3	1
F16AB-PA00351	Neos R Trail Stem 17/170	17/170	4	1
F16AB-PA00352	Neos R Trail Stem 18/170	18/170	5	1
F16AB-PA00353	Neos R Trail Stem 19/170	19/170	6	1
F16AB-PA00354	Neos R Trail Stem 20/170	20/170	7	1
F16AB-PA00355	Neos R Trail Stem 14/205	14/205	8	1
F16AB-PA00356	Neos R Trail Stem 15/205	15/205	9	1
F16AB-PA00357	Neos R Trail Stem 16/205	16/205	10	1
F16AB-PA00358	Neos R Trail Stem 17/205	17/205	11	1
F16AB-PA00359	Neos R Trail Stem 18/205	18/205	12	1
F16AB-PA00360	Neos R Trail Stem 19/205	19/205	13	1
F16AB-PA00361	Neos R Trail Stem 20/205	20/205	14	1
F16AB-PA00362	Neos R Trail Stem 21/205	21/205	15	1
F16AB-PA00363	Neos R Trail Stem 22/205	22/205	16	1
F16AB-PA00375	T-handle	/	17	1
F16AB-PA00376	Neos R Stem Inserter	/	18	1
F16AB-PA00377	Neos R Extractor	/	19	1
F16AB-PA00379	Osteotome 1	1	20	1
F16AB-PA00380	Osteotome 2	2	21	1
F16AB-PA00381	Osteotome 3	3	22	1
F16AB-PA00382	Neos R Stem Extractor Connector	/	23	1
F16AB-PA00383	Neos R Stem Insert Handle	/	24	1
F16AB-PA00364	Neos R Reamer Φ12	Φ12	25	1
F16AB-PA00365	Neos R Reamer Φ13	Φ13	26	1
F16AB-PA00366	Neos R Reamer Φ14	Φ14	27	1
F16AB-PA00367	Neos R Reamer Φ15	Φ15	28	1
F16AB-PA00368	Neos R Reamer Φ16	Φ16	29	1
F16AB-PA00369	Neos R Reamer Φ17	Φ17	30	1
F16AB-PA00370	Neos R Reamer Φ18	Φ18	31	1
F16AB-PA00371	Neos R Reamer Φ19	Φ19	32	1
F16AB-PA00372	Neos R Reamer Φ20	Φ20	33	1
F16AB-PA00373	Neos R Reamer Φ21	Φ21	34	1
F16AB-PA00374	Neos R Reamer Φ22	Φ22	35	1
F16AB-PA00059	Trial Femoral Head 28S	28S	36	1
F16AB-PA00060	Trial Femoral Head 28M	28M	37	1
F16AB-PA00061	Trial Femoral Head 28L	28L	38	1
F16AB-PA00062	Trial Femoral Head 28XL	28XL	39	1
F16AB-PA00063	Trial Femoral Head 24S	24S	40	1
F16AB-PA00064	Trial Femoral Head 24M	24M	41	1
F16AB-PA00065	Trial Femoral Head 24L	24L	42	1

P/N	Name	Specification	No	Qty
F16AB-PA00465	Trial Femoral Head 32S	32S	43	1
F16AB-PA00466	Trial Femoral Head 32M	32M	44	1
F16AB-PA00467	Trial Femoral Head 32L	32L	45	1
F16AB-PA00468	Trial Femoral Head 32XL	32XL	46	1
F16AB-PA00498	Trial Femoral Head 36S	36S	47	1
F16AB-PA00499	Trial Femoral Head 36M	36M	48	1
F16AB-PA00500	Trial Femoral Head 36L	36L	49	1
F16AB-PA00501	Trial Femoral Head 36XL	36XL	50	1
F16AB-PA00044	Medullary Initiator	/	51	1
F16AB-PA00067	Femoral Head Impactor	/	52	1
F16AB-PA00410	Head Extractor	/	53	1
F16AB-PA00385	NEOS Revision Stem Instrument Case	/	54	1
			Total	54

Option (\* are Optional tools)

P/N	Name	Specification	No	Qty
F16AB-PA00378	Neos R Extractor Connector	/	※1	1

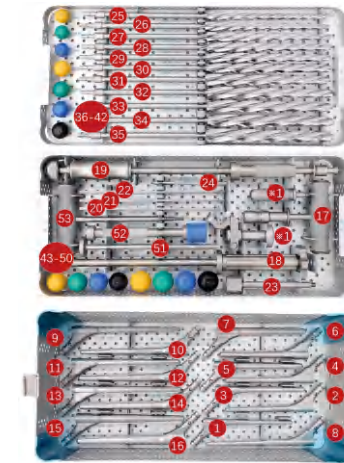

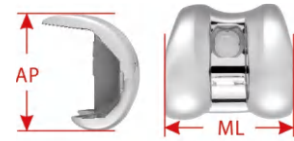

Femoral Component

P/N	Materials	Specification	L/R	AP(mm)	ML(mm)
F13BB-PA00004	CoCrMo casted	F1	L	53	57
F13BB-PA00005	CoCrMo casted	F1	R	53	57
F13BB-PA00006	CoCrMo casted	F2	L	56	60
F13BB-PA00007	CoCrMo casted	F2	R	56	60
F13BB-PA00008	CoCrMo casted	F3	L	59	63
F13BB-PA00009	CoCrMo casted	F3	R	59	63
F13BB-PA00010	CoCrMo casted	F4	L	61	66
F13BB-PA00011	CoCrMo casted	F4	R	61	66
F13BB-PA00012	CoCrMo casted	F5	L	65	71
F13BB-PA00013	CoCrMo casted	F5	R	65	71

Femoral Instrument Set (F16AB-PA00168)

P/N	Name	Specification	No	Qty
F16AB-PA00169	Bone File	/	1	1
F16AB-PA00170	IM Drill	/	2	1
F16AB-PA00171	Alignment Rod	/	3	1
F16AB-PA00172	Femoral Alignment Tower	/	4	1
F16AB-PA00173	IM Rod 400mm	/	5	1
F16AB-PA00174	IM Rod Handle	/	6	1
F16AB-PA00176	Anterior Reference Guide	/	7	1
F16AB-PA00177	Distal Femoral Cutting Block	/	8	1
F16AB-PA00178	Distal Femoral Locating Device Outrigger	/	9	1
F16AB-PA00179	Distal Femoral Locating Device	/	10	1
F16AB-PA00170	Steinmann Pin	/	11	8
F16AB-PA00181	4 in 1 Cutting Guide F1	F1	12	1
F16AB-PA00182	4 in 1 Cutting Guide F2	F2	13	1
F16AB-PA00183	4 in 1 Cutting Guide F3	F3	14	1
F16AB-PA00184	4 in 1 Cutting Guide F4	F4	15	1
F16AB-PA00185	4 in 1 Cutting Guide F5	F5	16	1
F16AB-PA00186	Removable Handle	/	17	2
F16AB-PA00187	Tibial Retractor	/	18	1
F16AB-PA00188	Pin Puller	/	19	1
F16AB-PA00189	Femoral Impactor	/	20	1

P/N	Name	Specification	No	Qty
F16AB-PA00190	Femoral Insert/Extract	/	21	1
F16AB-PA00191	Femoral Noth Guide F1	F1	22	1
F16AB-PA00192	Femoral Noth Guide F2	F2	23	1
F16AB-PA00193	Femoral Noth Guide F3	F3	24	1
F16AB-PA00194	Femoral Noth Guide F4	F4	25	1
F16AB-PA00195	Femoral Noth Guide F5	F5	26	1
F16AB-PA00196	Femoral osteotome	/	27	1
F16AB-PA00197	Femoral Box Trial F1	F1	28	1
F16AB-PA00198	Femoral Box Trial F2	F2	29	1
F16AB-PA00199	Femoral Box Trial F3	F3	30	1
F16AB-PA00200	Femoral Box Trial F4	F4	31	1
F16AB-PA00201	Femoral Box Trial F5	F5	32	1
F16AB-PA00202	Femur Trial F1 Left	F1 L	33	1
F16AB-PA00203	Femur Trial F1 Right	F1 R	34	1
F16AB-PA00204	Femur Trial F2 Left	F2 L	35	1
F16AB-PA00205	Femur Trial F2 Right	F2 R	36	1
F16AB-PA00206	Femur Trial F3 Left	F3 L	37	1
F16AB-PA00207	Femur Trial F3 Right	F3 R	38	1
F16AB-PA00208	Femur Trial F4 Left	F4 L	39	1
F16AB-PA00209	Femur Trial F4 Right	F4 R	40	1
F16AB-PA00210	Femur Trial F5 Left	F5 L	41	1
F16AB-PA00211	Femur Trial F5 Right	F5 R	42	1
F16AB-PA00212	Femoral Box Trial Screw Driver	/	43	1
F16AB-PA00213	Pin Inserter	/	44	1
F16AB-PA00214	Universal Handle	/	45	1
F16AB-PA00215	Femoral Retractor	/	46	1
F16AB-PA00216	Femoral Instrument Case	/	47	1
			Total	55

Option(※ are Optional tools)

P/N	Name	Specification	No	Qty
F16AB-PA00175	Posterior Reference Guide	/	※1	1



Tibial Insert

P/N	Materials	Specification	Thickness(mm)	AP(mm)	ML(mm)
F13BB-PA00014	UHMWPE	T0	8	41	61
F13BB-PA00015	UHMWPE	T0	10	41	61
F13BB-PA00016	UHMWPE	T0	12.5	41	61
F13BB-PA00017	UHMWPE	T0	15	41	61
F13BB-PA00018	UHMWPE	T1	8	43	64
F13BB-PA00019	UHMWPE	T1	10	43	64
F13BB-PA00020	UHMWPE	T1	12.5	43	64
F13BB-PA00021	UHMWPE	T1	15	43	64
F13BB-PA00022	UHMWPE	T1+	8	45	67
F13BB-PA00023	UHMWPE	T1+	10	45	67
F13BB-PA00024	UHMWPE	T1+	12.5	45	67
F13BB-PA00025	UHMWPE	T1+	15	45	67
F13BB-PA00026	UHMWPE	T2+	8	47	71
F13BB-PA00027	UHMWPE	T2+	10	47	71
F13BB-PA00028	UHMWPE	T2+	12.5	47	71
F13BB-PA00029	UHMWPE	T2+	15	47	71
F13BB-PA00030	UHMWPE	T3+	8	51	76
F13BB-PA00031	UHMWPE	T3+	10	51	76
F13BB-PA00032	UHMWPE	T3+	12.5	51	76
F13BB-PA00033	UHMWPE	T3+	15	51	76



Tibial Tray

P/N	Materials	Specification	L/R	AP(mm)	ML(mm)
F13BB-PA00034	Tc4 Forged	T0	-	41	61
F13BB-PA00035	Tc4 Forged	T1	-	43	64
F13BB-PA00036	Tc4 Forged	T1+	-	45	67
F13BB-PA00037	Tc4 Forged	T2+	-	47	71
F13BB-PA00038	Tc4 Forged	T3+	-	51	76



Tibial Instrument Set (F16AB-PA00217)

P/N	Name	Specification	No	Qty
F16AB-PA00218	Tibial Insert Extractor	/	1	1
F16AB-PA00219	Tibial Retractor	/	2	1
F16AB-PA00220	Tibial Tray Inserter	/	3	1
F16AB-PA00221	Polyethylene Component Impactor	/	4	1
F16AB-PA00222	Universal Tibial Tray Impactor	/	5	1
F16AB-PA00223	Slap Hammer Attachment	/	6	1
F16AB-PA00224	Spacer Block 8mm	8mm	7	1
F16AB-PA00225	Spacer Block 10mm	10mm	8	1
F16AB-PA00226	Spacer Block 12.5mm	12.5mm	9	1
F16AB-PA00227	Spacer Block 15mm	15mm	10	1
F16AB-PA00228	Extension Shim 1mm	1mm	11	1
F16AB-PA00229	Tibial Drill Bush 0-2	0-2	12	1
F16AB-PA00230	Tibial Drill Bush 3	3	13	1
F16AB-PA00231	Tibial Kell Bush 0-2	0-2	14	1
F16AB-PA00232	Tibial Kell Bush 3	3	15	1
F16AB-PA00233	Tibial Keel Punch Guide 0-2	0-2	16	1
F16AB-PA00234	Tibial Keel Punch Guide 3	3	17	1
F16AB-PA00235	Tibial Drill 15mm 0-2	0-2	18	1
F16AB-PA00236	Tibial Drill 17mm 3	3	19	1
F16AB-PA00237	Tibial Alignment Rod	/	20	1
F16AB-PA00238	Tibial Alignment Ankle Clamp	/	21	1
F16AB-PA00239	Tibial Alignment Proximal Device	/	22	1
F16AB-PA00240	Tibial Alignment Proximal Device with Spike	/	23	1
F16AB-PA00241	Slotted Tibial Cutting Block 0°	0°	24	1
F16AB-PA00242	Slotted Tibial Cutting Block 3°	3°	25	1
F16AB-PA00243	Slotted Tibial Cutting Block 5°	5°	26	1
F16AB-PA00244	Stylus	/	27	1
F16AB-PA00245	Tibial Tray Trial T0	T0	28	1
F16AB-PA00246	Tibial Tray Trial T1	T1	29	1
F16AB-PA00247	Tibial Tray Trial T1+	T1+	30	1
F16AB-PA00248	Tibial Tray Trial T2+	T2+	31	1
F16AB-PA00249	Tibial Tray Trial T3+	T3+	32	1
F16AB-PA00250	Tibial Trial Alignment Handle	/	33	1
F16AB-PA00251	Tibial Trial Insert Remove Tool	/	34	1
F16AB-PA00252	Endless Steinmann Pin	/	35	4
F16AB-PA00253	Tibial Insert Trial T0-8	T0-8	36	1
F16AB-PA00254	Tibial Insert Trial T0-10	T0-10	37	1
F16AB-PA00255	Tibial Insert Trial T0-12.5	T0-12.5	38	1
F16AB-PA00256	Tibial Insert Trial T0-15	T0-15	39	1
F16AB-PA00257	Tibial Insert Trial T1-8	T1-8	40	1
F16AB-PA00258	Tibial Insert Trial T1-10	T1-10	41	1
F16AB-PA00259	Tibial Insert Trial T1-12.5	T1-12.5	42	1

P/N	Name	Specification	No	Qty
F16AB-PA00465	Tibial Insert Trial T1-15	T1-15	43	1
F16AB-PA00466	Tibial Insert Trial T1+-8	T1+-8	44	1
F16AB-PA00467	Tibial Insert Trial T1+-10	T1+-10	45	1
F16AB-PA00468	Tibial Insert Trial T1+-12.5	T1+-12.5	46	1
F16AB-PA00498	Tibial Insert Trial T1+-15	T1+-15	47	1
F16AB-PA00499	Tibial Insert Trial T2+-8	T2+-8	48	1
F16AB-PA00500	Tibial Insert Trial T2+-10	T2+-10	49	1
F16AB-PA00501	Tibial Insert Trial T2+-12.5	T2+-12.5	50	1
F16AB-PA00044	Tibial Insert Trial T2+-15	T2+-15	51	1
F16AB-PA00067	Tibial Insert Trial T3+-8	T3+-8	52	1
F16AB-PA00410	Tibial Insert Trial T3+-10	T3+-10	53	1
F16AB-PA00385	Tibial Insert Trial T3+-12.5	T3+-12.5	54	1
F16AB-PA00501	Tibial Insert Trial T3+-15	T3+-15	55	1
F16AB-PA00044	Tibia Instrument Case	/	56	1
			Total	59





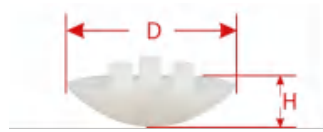

Patellar Component

P/N	Materials	Specification	L/R	D(mm)	D(mm)
F13BB-PA00001	UHMWPE	-	-	32	8
F13BB-PA00002	UHMWPE	-	-	35	8.5
F13BB-PA00003	UHMWPE	-	-	38	9

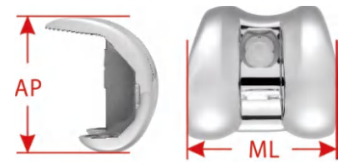

Femoral component specification

Model	F1	F2	F3	F4	F5
AP(mm)	53	56	59	61	65
ML(mm)	57	60	63	66	71



Tibial tray specification

Model	T0	T1	T1+	T2+	T3+
AP(mm)	41	43	45	47	51
ML(mm)	61	64	67	71	76

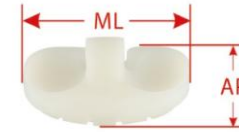

Tibial Insert specification

Model	T0	T1	T1+	T2+	T3+
AP(mm)	41	43	45	47	51
ML(mm)	61	64	67	71	76
H(mm)	8、10、12.5、15				

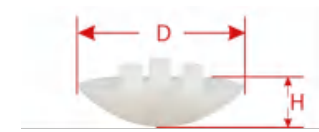

Patellar component specification

Name	Patellar component		
D(mm)	32	35	38
H(mm)	8	8.5	9

Size Table

Tibial Tray	Tibial Insert	Femoral Component				
		F1	F2	F3	F4	F5
T0	T0					
T1	T1					
T1 <sup>+</sup>	T1 <sup>+</sup>					
T2 <sup>+</sup>	T2 <sup>+</sup>					
T3 <sup>+</sup>	T3 <sup>+</sup>					



